



Kerb/Upstand Sizes (by others)

Internal Kerb Upstand Size 500mm x 500mm

External Kerb/Upstand Size 660mm x 600mm

Kerb/Upstand thickness 80mm (including weathering)

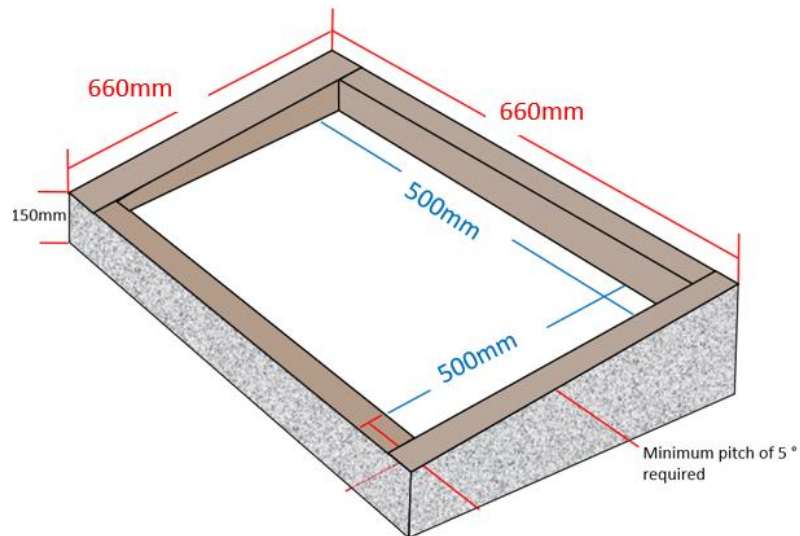

Fixed Rooflight Sizes

Internal Opening Size 500mm x 500mm

External Frame Size 681mm x 681mm

Frame Height 119mm

